

## Access Doors:

Doors	Cutout Dimensions	
	<b>A</b> Width	<b>B</b> Height
<b>TEAD18-B</b>	16.25	19
<b>TEAD30-B</b>	28.25	19
<b>TEAD36-B</b>	34.25	19
<b>TEAD42-B</b>	40.25	19

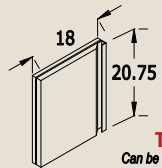

**TEAD18-B**  
Can be installed either left or right hand.

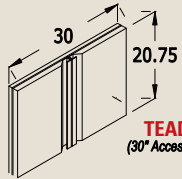

**TEAD30-B**  
(30° Access Doors)

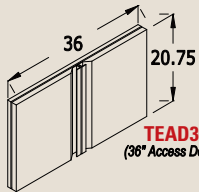

**TEAD36-B**  
(36° Access Doors)

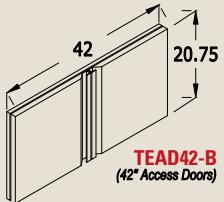

**TEAD42-B**  
(42° Access Doors)

# TECHNICAL SPECIFICATIONS

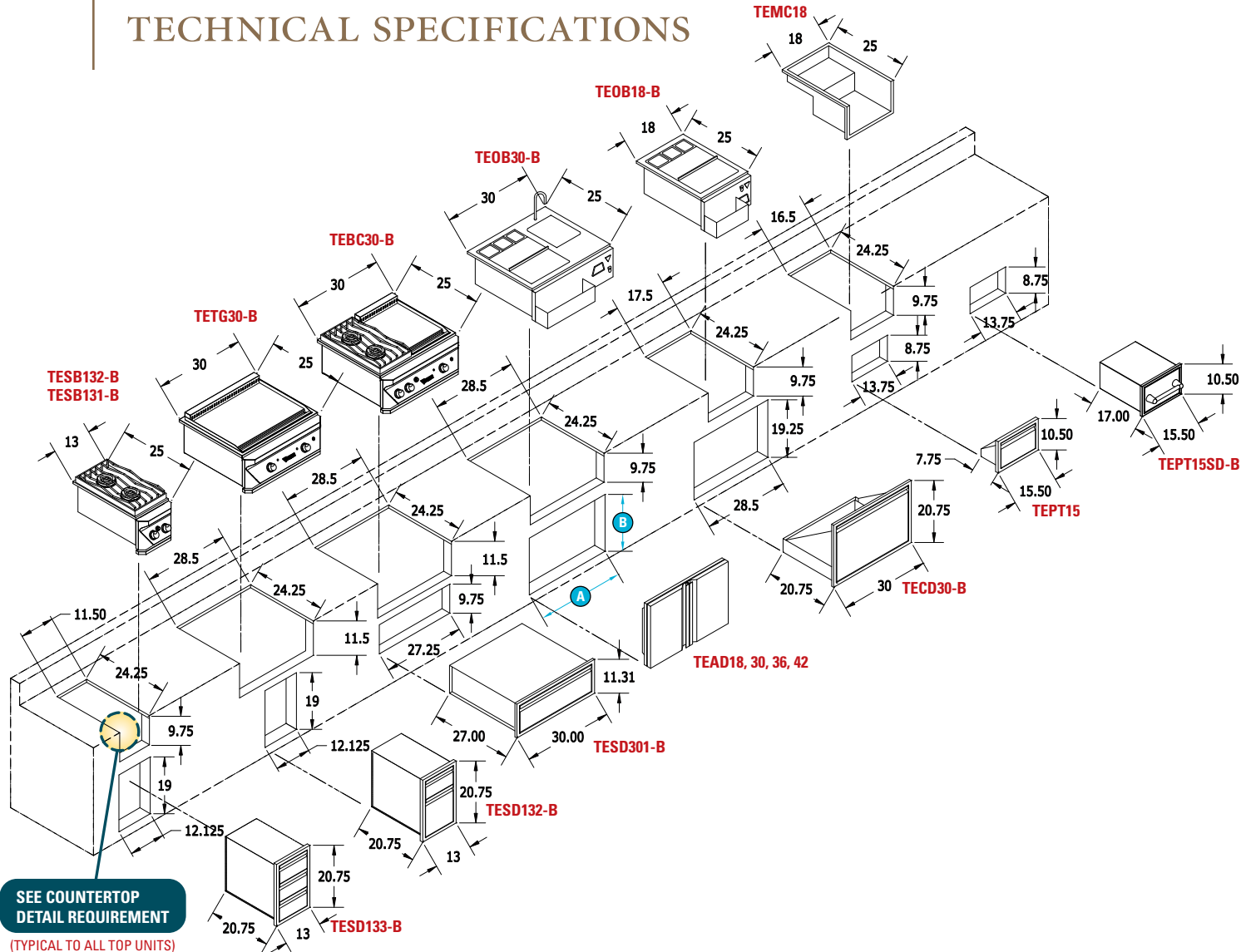

## COUNTERTOP DETAIL REQUIREMENT

(TYPICAL TO ALL TOP UNITS)

\* ADD 3.25 TO ALLOW FOR HOOD OPENING

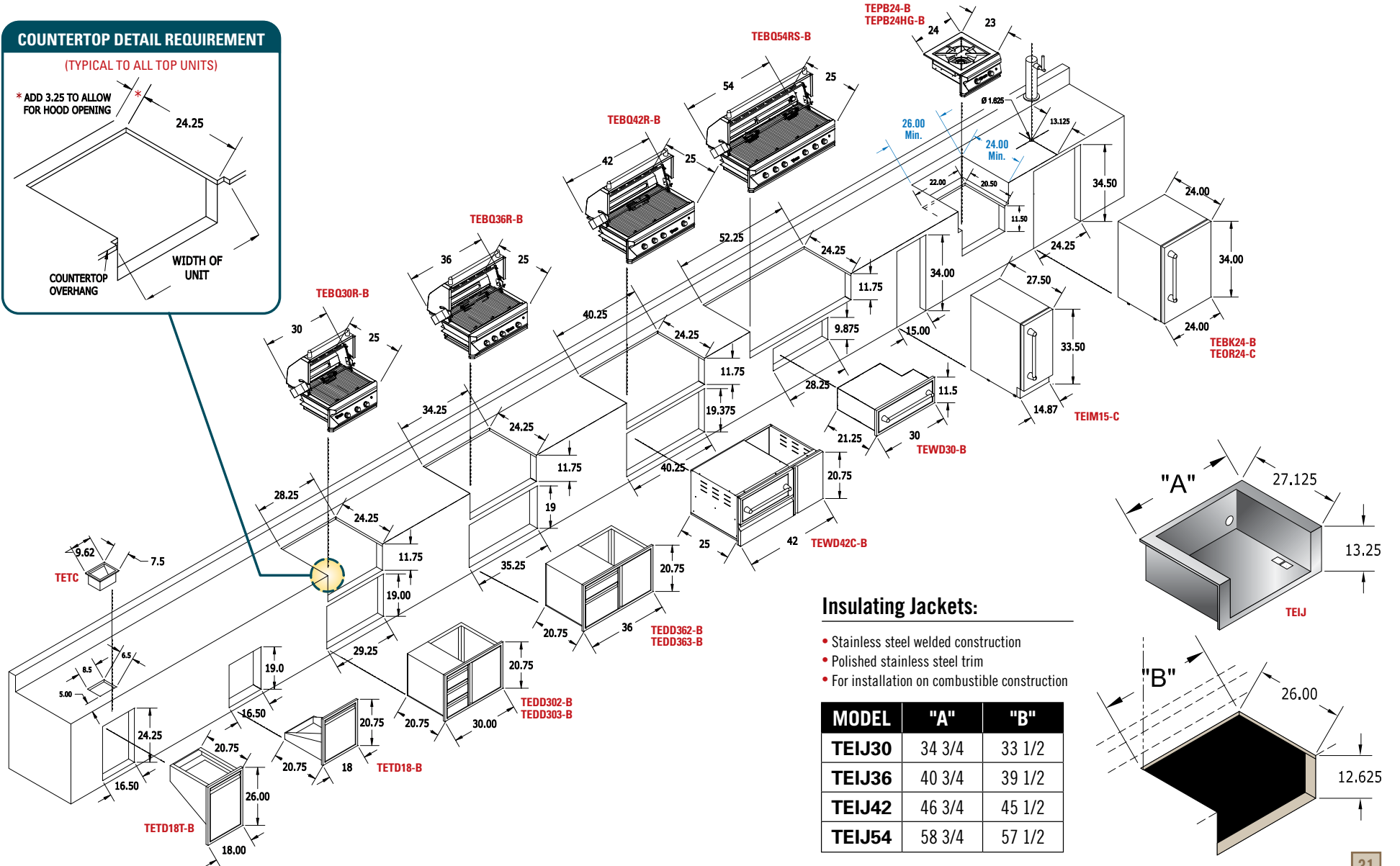
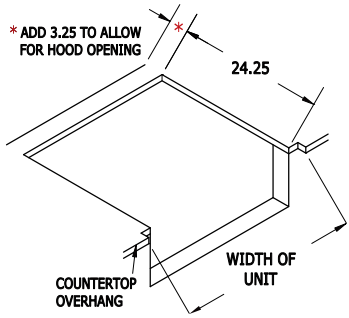

### Insulating Jackets:

- Stainless steel welded construction
- Polished stainless steel trim
- For installation on combustible construction

MODEL	"A"	"B"
TEIJ30	34 3/4	33 1/2
TEIJ36	40 3/4	39 1/2
TEIJ42	46 3/4	45 1/2
TEIJ54	58 3/4	57 1/2

